

KOS1700 USER GUIDE  **To avoid the risk of electric shock and fire Please read this instructions document fully before use.**

DIN rail mounted Temperature/process conditioner with universal input, output and supply, dual trip relay change over contacts. USB configuration, user push button function and LED state indication. Intended use Industrial process monitoring and control.

DISEÑOS Y TECNOLOGIA S.A., Xarol, 6B, P.I. Les Guixeres, 08915 Badalona, ESPAÑA. Tel +34 933 394 758. www.ditel.es



IMPORTANT SAFETY REQUIREMENTS.

Max working voltage Terminals (1 to 10)	±30 V DC ±50mA
Max working voltage Terminals (11 to 18)	240 V ac, ± 240V dc
Isolation (11,12) to (1 to 10)	3750V
(11,12) to (13 – 18)	3750V
(13 – 18) to (1 to 10)	3750V

- This equipment is suitable for environment Installation category II pollution degree 1 and is classed as "PERMANENTLY CONNECTED EQUIPMENT".
- The equipment must be mounted inside an enclosure that provides protection >= IP65. In NORMAL USE, the equipment will only be accessed for maintenance by qualified personnel. Please ensure the equipment is mounted vertically with terminals (1 - 10) at the bottom. This will provide maximum ventilation and ensure correct operation of the cold junction sensor. This equipment may generate heat, ensure the enclosure size is adequate to dissipate heat. Be sure to consider any other equipment inside the enclosure.
- The equipment surfaces may be cleaned with a damp cloth. Use a mild detergent/water to damp cloth. Ensure the supply is off before cleaning and on completion of cleaning the equipment is completely dry before the supply is turned back ON.
- The equipment contains no serviceable parts, or internal adjustments. No attempt must be made to repair the product. Faulty equipment must be returned to the supplier for repair.
- To keep the safety distances, the relay contacts on the device must not be connected to both hazardous and non-hazardous volt.
- This equipment must be installed by a qualified person. All electrical wiring must be carried out in accordance with the appropriate regulations for the place of installation.
- Dc supply must be derived from a local supply and not a distribution system.
- To maintain CE EMC requirements, input supply and voltage output wires must be less than 30 metres.
- Supply (22 to 240) V ac 50/60 Hz (20 to 240) V dc. If supply is a HAZARDOUS VOLTAGE a supply isolation switch must installed close to the equipment with the "OFF" position clearly marked. Also, the supply must be fused with a suitable 1A (T) fuse (circuit breaker) installed close the equipment.
- Relay1,2 outputs are isolated from each other. Max switching current (1 A @ 240 V ac, 1 A @ 30 V dc) Non-Inductive. Fuse relay circuits with a suitable 2A (T) fuse installed close the equipment. If a HAZARDOUS VOLTAGE is being a switched then an isolation switch must also be installed close to the equipment with the off position clearly marked.
- Receive and unpack Please inspect packaging and instrument thoroughly for any signs of transit damage. If damage is present do not use the equipment safety protection may be affected. Please return damaged equipment to supplier.
- USB configuration can be performed without the supply being connected. For safety reasons, use a 24 VDC for functional test of unit prior to fixed installation. The following operations should only be carried out on a disconnected device and under ESD safe conditions: General mounting, connection and disconnection of wires. Troubleshooting the device.

• Specification, please refer to supplier's web site latest product data sheet for full specification. Basic specification

Supply	(22 to 240) V ac 50/60 Hz or (20 to 240) V dc 3W max isolation 3.75KV to all other ports
Relay contacts (form C)	240V ac 50/60 Hz @ 1A or 30V dc @ 1 A (non-inductive loads) isolation 3.75KV to all other ports
Input (SELV)	Thermocouple, RTD, current ± 30mA, voltage (± 50.0mV, ±200mV, ± 1V, ±10.0V), slide wire > 1K
Output (SELV)	Current (0 to 20) mA, Voltage (0 to 10) V
Ambient	(-20 to 70) °C Approvals EN61010_1, EN61326

 **Configuration (Read the IMPORTANT SAFETY REQUIREMENTS)** During configuration the equipment takes its power from the USB port, therefore no power connection is required. The equipment can be configured whilst powered but the computer used must be isolated from the supply earth to avoid grounded earth loop effects. Refer to configuration help guide for further information on configuration methods.

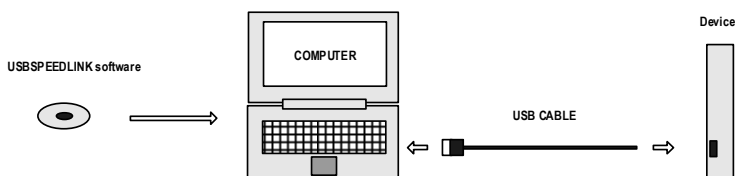

Default settings Type P, Sample rate 1000mS, Units °C, Output (4 to 20) mA, High range 100.0 °C, low range 0.0 °C, Burnout upscale, User adjust off, Relays off delays 0, Damping off.

⚠ Installation (Read the IMPORTANT SAFETY REQUIREMENTS)

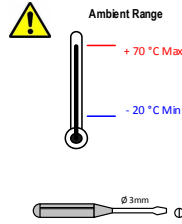
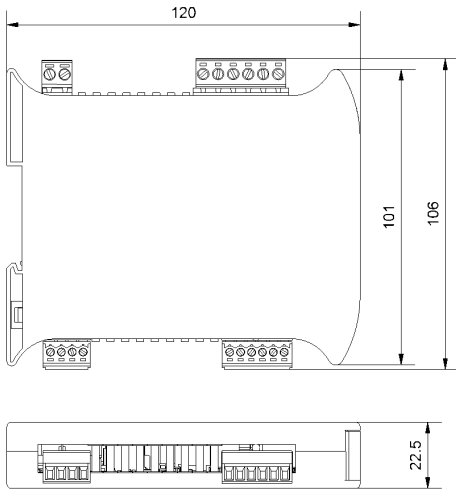

The equipment must be mounted on a DIN rail style DIN EN 50022 inside a plastic or metal enclosure with a protection level \geq IP65. All wiring must be secured. Max cable sizes 2.5 mm. Connection two-part screw terminals.



RELAY OUTPUT

RATINGS
 240 V AC @ 1A
 30 V DC @ 1A
 Non Inductive Load

RELAY 1	B	18
	A	17
	C	16
RELAY 2	B	15
	A	14
	C	13

SUPPLY

(22 to 240) V AC
 50/60 Hz
 (20 to 240) V DC

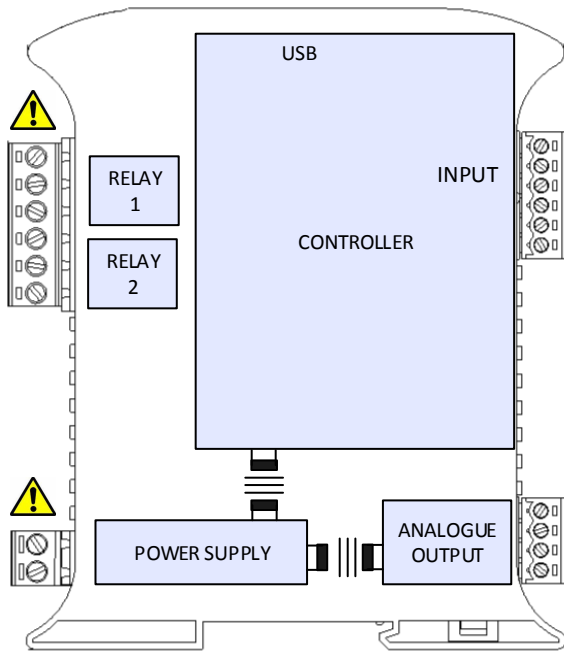

INPUT

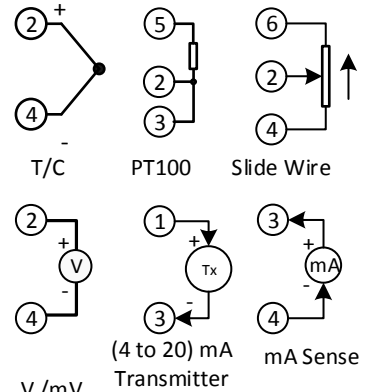

ANALOGUE OUTPUT

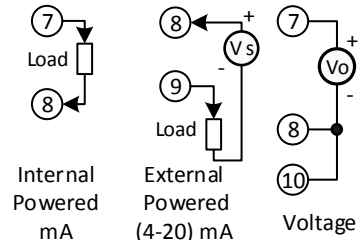

Input connections for cable length >3 metres use screen or twisted pair cables. Thermocouple connections use the correct compensating cable. PT100 connection all wires must be equal length (resistance). Max cable run 30 metres.

Output connections for cable length >3 metres use screen or twisted pair cables. For current outputs max cable run 1000 metres, Voltage output 30 Metres.

Relay connections – relays 1 and 2 are isolated from each other. As stated in the IMPORTANT SAFETY REQUIREMENTS relay circuit must be fused with a 2A (T) fuse and provision provided to isolate the circuit when hazardous voltages are being switched.

Supply max cable run 30 metres. As stated in the IMPORTANT SAFETY REQUIREMENTS the supply must be fused with a 1A (T) fuse and provision provided to isolate the circuit when hazardous voltages are being switched.

USER TRIM

Screwdriver

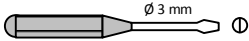

Digital mA meter



Supply



Input Simulator

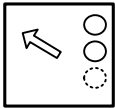

or sensor



User trim function allows manual adjustment of the analogue output, this is useful for minor calibration adjustment or trimming out any sensor error, $\pm 5\%$ of range adjustment is available at both offset and span. Raise and lower buttons are provided on the front panel, of the transmitter, accessed using a 3 mm flat blade screw driver. Insert the screw driver into the appropriate slot to operate the button. The button has a click action.

The transmitter will automatically detect the correct trim point (offset or span) based on the output signal. Offset will be trimmed when the current is in the offset band, span when the current is in the span band. No trim action occurs at any other current. Note this function needs to be selected by the software configuration tool before use. To lock setting after adjustment the operator can again use the tool to turn this function off, (select the option to save trim when downloading config).

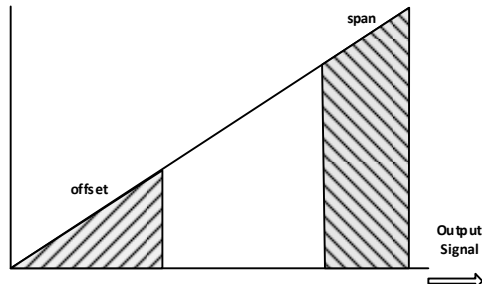

Range	Offset	Span
(4 to 20) mA	(3.8 to 6) mA	(18 to 22) mA
(0 to 20) mA	(0 to 2) mA	(18 to 22) mA
User mA	User low ± 2 mA (Min 0 mA)	User High ± 2 mA (Max 24 mA)
(0 to 10) V	(0 to 1) V	(9 to 11) V
User V	User low ± 1 V (Min 0 V)	User High ± 1 V (Max 12 V)

METHOD

1.0 Connect transmitter to a suitable input simulator or sensor. Connect supply, connecting a digital meter to monitor output. Turn supply on, set input to offset/span calibration point.

IMPORTANT - IF PERFORMING TWO POINT CAL - ALWAYS CAL OFFSET FIRST.

2.0 Enter trim menu by pressing "raise" button for > two seconds. When the trim menu is open the range LED will flash :-

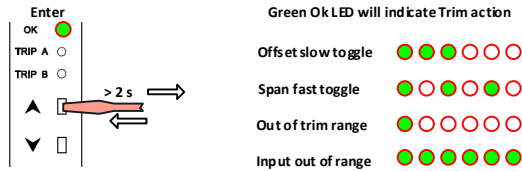

3.0 Trim output current by pressing either the raise or lower button, single click to step advance, or press continuously to auto advance.

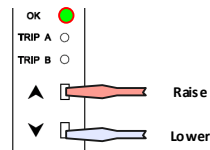

4.0 Once trim is complete allow 30 seconds with no button press, the transmitter will time out and return to normal operation.

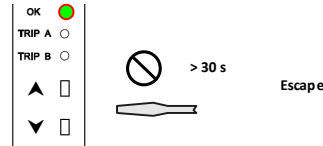

Sensor Fault Conditions

TC or RTD Input.

Analogue output.

On loss of the input signal the SEM1700 will go into burnout condition, this is selectable (high, low, or user).

Relay output.

The relays will trip (change state from the normal condition) on loss of the input signal, unless set to the off position.

Process Input.

Analogue output.

Loss of the input signal does not effect the output in the same way as with TC or RTD.

With process inputs a lost signal will be seen as a process value scaled to the equivalent of a zero electrical input.

If the process value is below the process low range the output will go to its low scale value (less approximately 10% of the output range)

Relay output.

Only with low alarm or low control will the relays trip (change state from the normal condition) on under range/loss of input signal.

USER RANGE CONFIGURATION

This function allows two point manual configuration of the re-transmission current (voltage) at low and high range against a live input signal. This is useful for on-site configuration, example with a slide wire input the user manually positions the slide at both low and high positions and configure the unit to operate over the range. Configuration is achieved using either the raise (span) or lower (offset) buttons.

To operate this function must first be selected using the software configuration tool. The operator may lock this function (once set) by turning off the function.

Screwdriver

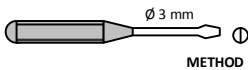

METHOD



1.0 Connect transmitter to a suitable input simulator or sensor. Connect supply, turn supply on, set input to either offset or span calibration point.

2.0 To enter configuration, set input to desired high or low setting and wait 10 seconds. Press and hold raise (high) or lower (low) button on for > 2 s to enter.

3.0 Once the menu has been entered, quickly (within 1 second) apply a single press to the raise (high) or lower (low) button to store setting.

To abort configuration, allow config to time out by not pressing buttons for 5 seconds.

Input Simulator

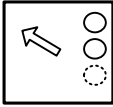

or sensor



The ok LED will then start to flash at a slow rate (low) or fast rate (high).

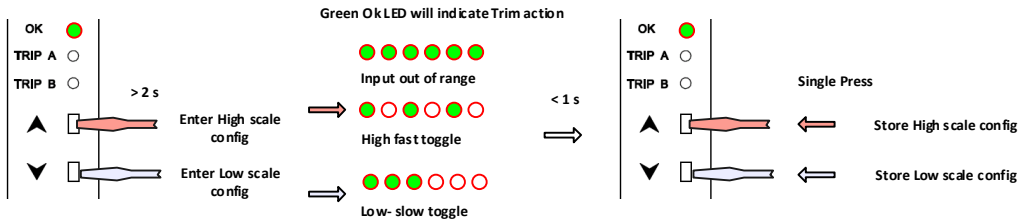

OUTPUT DAMPING

User adjustable damping of the analogue output is provided for both rising and falling signals. The adjustable range is (0 to 250) second for a (0 to 20) mA or (0 to 10) V swing.

To calculate the maximum rate of change of the output signal divide 20 mA (10 V) by the damping setting, example if the damping is set to 100 seconds the mA output will change at a maximum rate of (20/100) = 0.2 mA/Second. Use USB_LINK software to configure damping setting.

TRIP OUTPUTS

Dual trip change over contacts are available. The contacts are rated at 240 V ac 1 A (Non inductive) 30 V DC 1 A. An external snubber network is recommended when switching inductive circuits. Please ensure the snubber network is rated for the application. Four actions are provided, as detailed in the diagram below. The Alarm actions may also be used for inverted control applications, example the high alarm action can be used to control a cooling fan when used to control the temperature of a heat source. Adjustable setpoint and deadband are provided together with adjustable on and off delays for each trip. The delay range is (0 to 250) Seconds.

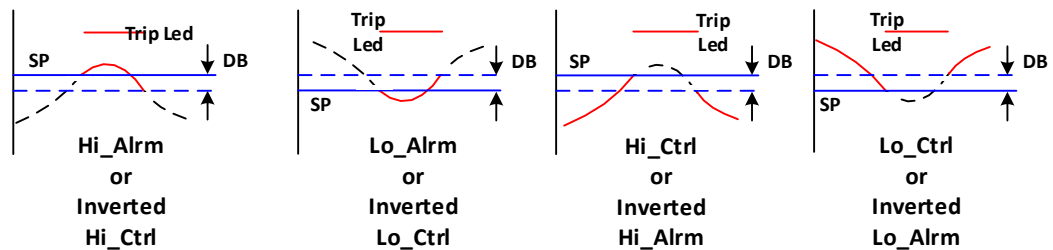

Action	Normal	Trip	Temperature Range Error	Power off
Hi_Alrm / Inverted Hi-Ctrl Lo_Alrm / Inverted Hi-Ctrl				
Hi_Ctrl / Inverted Hi_Alrm Lo_Ctrl / Inverted Lo_Alrm				

