



\*for selected parameters - details in the technical data

## ND45 - POWER NETWORK ANALYZER / RECORDER

- Measurement and recording of over 500 electric energy quality parameters acc. to EN 50160, EN 61000-4-30 standards.
- **Measuring class A.**
- Operation in 3 or 4-wire, 3-phase, balanced or unbalanced power networks.
- Analysis of current and voltage harmonics and interharmonics up to the 51 st for **class I**.
- Flicker.
- 4-quadrant energy measurement in **4 tariffs**.
- **Monitoring up to 6 additional energy meters with pulse output.**
- **Recording of measurements before and after events (dips & swells).**
- Configurable archives of actual values and events recording.
- Data archiving on an SD card - memory up to 32 GB.
- E-mail messages in case of alarm occurs,
- Web server (HTTP protocol), FTP server, DHCP client.
- Interfaces: **RS-485 Modbus Slave**, Ethernet 100 Base-T (Modbus TCP/IP), USB Device & Host.
- Colour touch screen: LCD TFT 5.6", 640 x 480 pixels.
- IP54 protection grade from the frontal side.
- Automatic synchronization of RTC clock with the NTP time server.

### EXAMPLE OF APPLICATION

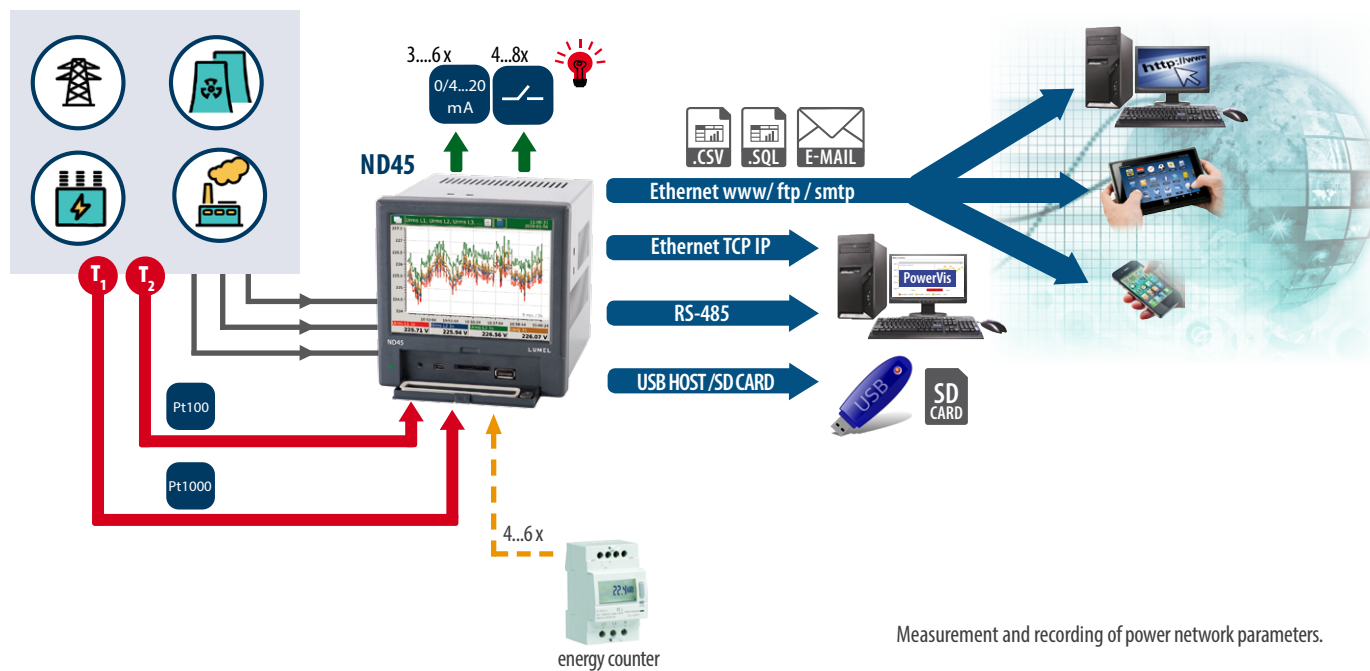

Measurement and recording of power network parameters.

## MEASUREMENT AND VISUALIZATION OF POWER NETWORK PARAMETERS

### Aggregated values for 3 seconds, 10 minutes and two hours:

- phase voltages  $U_1, U_2, U_3, U_{123} \text{ avg}$
- phase current  $I_1, I_2, I_3, I_{123} \text{ avg}$
- active phase powers  $P_1, P_2, P_3, \Sigma P_{123}, P_{123} \text{ avg}$
- reactive phase powers  $Q_1, Q_2, Q_3, \Sigma Q_{123}, Q_{123} \text{ avg}$
- apparent phase powers  $S_1, S_2, S_3, \Sigma S_{123}, S_{123} \text{ avg}$
- active power factors  $PF_1, PF_2, PF_3, PF_{123} \text{ avg}$
- power factor distortion  $dPF_1, dPF_2, dPF_3, dPF_{123} \text{ avg}$
- reactive/active power factors  $tg\phi_1, tg\phi_2, tg\phi_3, tg\phi_{123} \text{ avg}$
- phase-to-phase voltages  $U_{12}, U_{31}, U_{23}, U_{123} \text{ avg}$
- current in neutral wire  $I_n$
- the angle between the voltage and current  $\phi_1, \phi_2, \phi_3, \phi_1, \phi_{123} \text{ avg}$  (degrees and radians)
- voltage phase-to-phase angle  $\sphericalangle U_{12}, \sphericalangle U_{31}, \sphericalangle U_{23}, \sphericalangle U_{123} \text{ avg}$

### Other parameters:

- frequency (aggregation for 1 and 10 seconds)
- temperature/ resistance values (two channels)
- Demand values: P, Q, S, U, I (15-minute, 30-minute or 1 hour).
- energy: active imported/exported, reactive imported/exported and apparent. All energies are calculated for each phase and 3-phase parameters.
- factors: THD, THDS, THDG, PWH. Calculated for currents and voltages of each phase and 3-phase parameters.
- harmonics from 1 up to 51st for each phase of currents and voltages
- interharmonics from 1 up to 51st for each phase of currents and voltages
- the half wave voltage of each phase
- recording of dips, swells and overvoltages
- storage of minimum and maximum of measured values.

### FEATURES

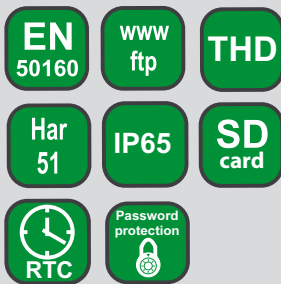

### INPUTS

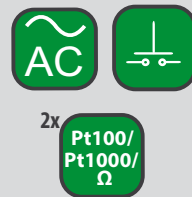

### OUTPUTS

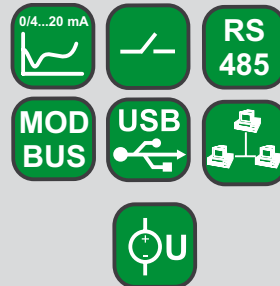

### GALVANIC ISOLATION

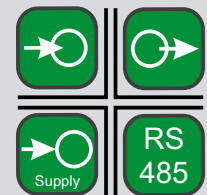

## TECHNICAL DATA

### INPUTS

Input type	Measuring range	Parameters	Basic error
Voltage input	230/400 V   57,7/100V   69.3/ 120 V	0.05..1.5 Un	± 0.1%
Current input	1 A or 5A	0.005..1.5 In	± 0.1%
Logic input	4 or 6 logic inputs: 0/5..24 V d.c.	switching frequency up to 50 Hz	
Input for temperature measurement	2 inputs: Pt100 (-200...850°C) lub Pt1000 (-200...850°C) , resistance: 0...5000 Ω		± 0.2%

### OUTPUTS

Output type	Properties
Analog output	3 or 6 programmable current outputs 0/4...20 mA, load resistance < 500 Ω
Relay output	4 or 8 programmable electromagnetic relays, voltageless NO contacts, load capacity 250 V a.c./1 A a.c.

### DIGITAL INTERFACES

Interface type	Properties
RS-485	interface: Modbus Slave, baud rate 300...115200 bit/s, transmission mode ASCII/RTU
USB	2 interfaces: Device & Host, USB v.2.0
Ethernet	100 Base-T, RJ45 socket, Modbus TCP/IP, web server (HTTP), FTP server, DHCP client

## RATED OPERATING CONDITIONS

<b>Supply voltage</b>	85 V..253 V a.c., 40...400Hz	90 V..300 V d.c.	power consumption: 15 VA, 35 VA (when loading)
<b>Ambient temperature</b>	work: 0 up to 50°C		storage: - 20...50°C
<b>Relative humidity</b>	< 75%		Condensation inadmissible
<b>Reaction against</b>	supply decays		Data and device state preservation
	supply recovery		Continuation of device work
<b>Short term load (5s)</b>	2 Un (max. 1000 V)		10 In
<b>Casing protection grade</b>	IP 54		
<b>Safety requirements</b>	Installation category III		EN 61010-1
	Pollution grade 2		
<b>Maximum phase-to-earth operating voltage</b>	RS485, temperature/resistance input, USB: 50V		EN 61010-1
	measuring circuit, relays, supply: 300 V		

## MEASURING RANGES AND ADMISSIBLE BASIC CONVERSION ERRORS

Measuring quantity	Measurement method	Range	Basic error
Voltage U RMS	<b>U RMS</b> averaged values: 200 ms class: B 1 s class: B 3 s class: <b>A or S</b> 10 min class: <b>A or S</b> 2 hrs class: <b>A or S</b>	<b>U RMS L-N (150% Un)</b> Un = 230 V 23.0..46..345.0 V (Ku=1) ..1.38 MV (Ku≠1) Un = 57.7V 5.7..11.5 ..86.5 V (Ku=1) ..280 kV (Ku≠1) Un = 69.3V 6.9..13.9 ..104.0 V (Ku=1) ..416 kV (Ku≠1)  <b>U RMS L-L (150% Un):</b> Un = 400 V 40.0..80.. 600.0 V (Ku=1) ..2.4 MV (Ku≠1) Un = 100V 10.0 ..20..120.0 V (Ku=1) ..480 kV (Ku≠1) Un = 120V 12.0 ..24..180.0 V (Ku=1) ..720 kV (Ku≠1)	<b>class A</b> acc. to EN 61000-4-30 <b>U RMS L-N</b> (10% U <sub>din</sub> - 150% U <sub>din</sub> ): ±0.1% U <sub>din</sub> .
Current I RMS	<b>I RMS:</b> averaged values: 200 ms class: B 1 s class: B 3 s class: <b>A or S</b> 10 min class: <b>A or S</b> 2 hrs class: <b>A or S</b>	<b>I RMS (150% In):</b> In = 1 A - 0.010..0.1..1.5 A (Ki=1) In = 5 A - 0.050..0.5..7.5 A (Ki=1) ..480.0 kA (Ki≠1)	<b>I RMS</b> (10% In - 150% In): ±0.1% of measurement
Frequency	Class S appointed from 10 or 12 cycles in 200 ms.	42.5 up to 57.5 Hz for 50 Hz a.c. of supply 51.0 up to 69.0 Hz for 60 Hz a.c. of supply	Class S acc. to EN 61000-4-30 ±0.050 Hz
	<b>Class A</b> appointed from 100 or 120 cycles in 10 s.		<b>Class A</b> acc. to EN 61000-4-30 ±0.010 Hz
Active, reactive and apparent power	<b>Active power:</b> Measured every 10 cycles (50 Hz) or 12 cycles (60 Hz) <b>Reactive power:</b> appointed from apparent and active power. <b>Apparent power:</b> appointed from value U RMS and I RMS.	Depends on voltage and actual ratio value.	acc. to EN 61557-12:  Active power: ± 0.5% P <sub>n</sub> Reactive power: ± 1% Q <sub>n</sub> Apparent power: ± 0.5% S <sub>n</sub>
Measuring quantity	Measurement method	Range	Basic error
Active imported/exported energy, reactive imported/exported energy, apparent energy	Measured every 10 cycles (50 Hz) or 12 cycles (60 Hz).  Separate measurement for exported, imported <b>active and reactive energy</b> .	Depends on voltage and actual ratio value.	acc. to EN 61557-12:  Active power: ± 0.5% Reactive power: ± 1% Apparent power: ± 2%
Active power factor, Power distortion factor	Active power factor : depends on U RMS, I RMS and active power. Power distortion factor depends on THD I.	-1,000 .. 0 .. 1,000	Power factor PF ± 0.01% Power distortion factor PF <sub>dist</sub> ± 0.05%
Harmonics of voltages and current	acc. to EN 61000-4-7, up to 51st harmonic Window: 10 cycles (for 50 Hz), 12 cycles (for 60 Hz). FFT: 4096 points	Voltage harmonics: 0.00 .. 100.00 % Current harmonics: 0.00 .. 100.00 %	Voltage harmonics – class I  ± 5% U <sub>rdg</sub> if U <sub>rdg</sub> > 1% ± 0.05% U <sub>n</sub> if U <sub>rdg</sub> < 1%  Current harmonics – class I  ± 5% U <sub>rdg</sub> if U <sub>rdg</sub> > 3% ± 0.5% U <sub>n</sub> if U <sub>rdg</sub> < 3%
THD U, THD I, THDG U, THDG I, THDS U, THDS I, PWHD U, PWHD I	acc. to EN 61000-4-7, up to 51st harmonic Window: 10 cycles (for 50 Hz), 12 cycles (for 60 Hz). FFT: 4096 points	THD U: 0.00 .. 100.00 % THD I: 0.00 .. 100.00 % THDG U: 0.00 .. 100.00 % THDG I: 0.00 .. 100.00 % THDS U: 0.00 .. 100.00 % THDS I: 0.00 .. 100.00 % PWHD U: 0.00 .. 100.00 % PWHD I: 0.00 .. 100.00 %	THD U: ±5% (50/60Hz) THD I: ±5% (50/60Hz) THDG U: ±5% (50/60Hz) THDG I: ±5% (50/60Hz) THDS U: ±5% (50/60Hz) THDS I: ±5% (50/60Hz) PWHD U: ±5% (50/60Hz) PWHD I: ±5% (50/60Hz)

where:

Ku - voltage transformer ratio  
Ki - current transformer ratio  
U<sub>din</sub> - declared input voltage

U<sub>rdg</sub>, I<sub>rdg</sub> - measurement values  
U<sub>n</sub>, I<sub>n</sub>, P<sub>n</sub>, Q<sub>n</sub> - nominal values

## EXAMPLES OF MEASURING DATA PRESENTATION

### Various forms of data display:

- digital display
- analog view,
- bargraphs,
- vector diagrams
- trends
- energy meter
- harmonics analysis
- energy meter.

Screen system log files.

Screens log alarms.

Control panel.

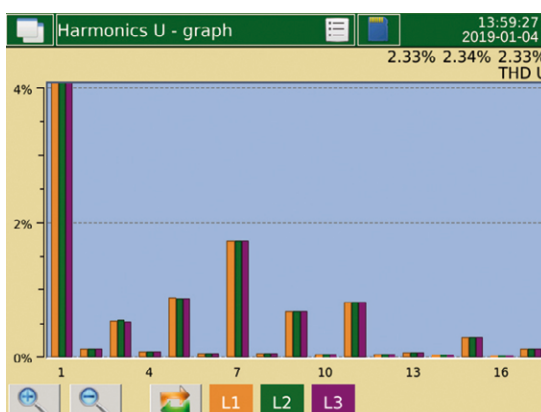
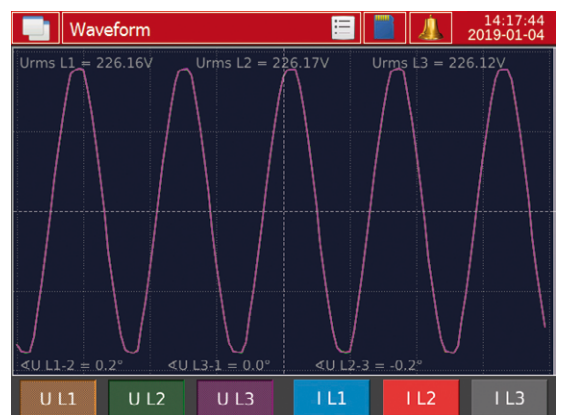
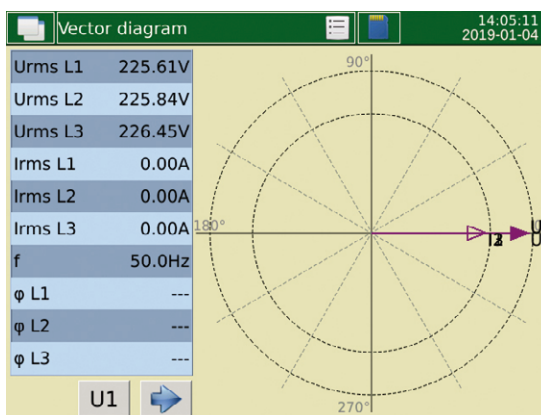
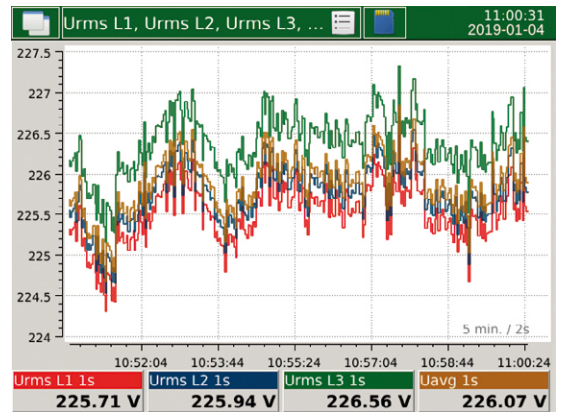
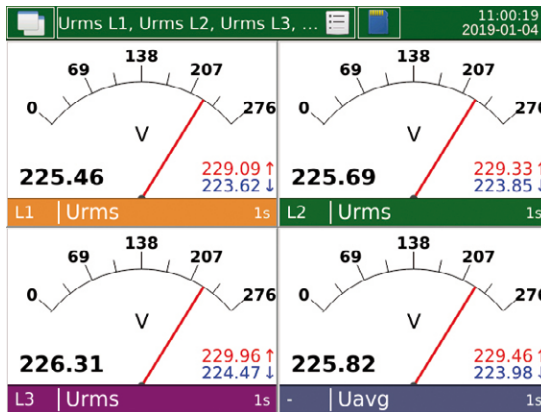
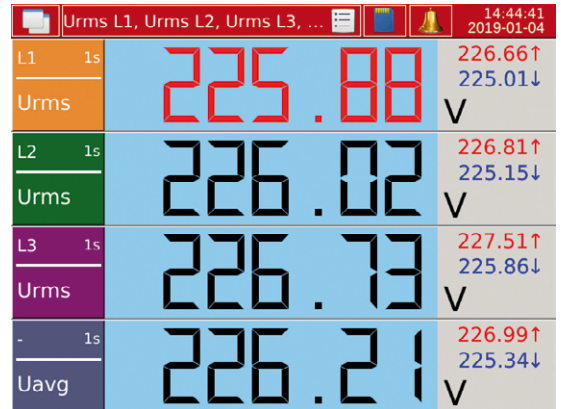
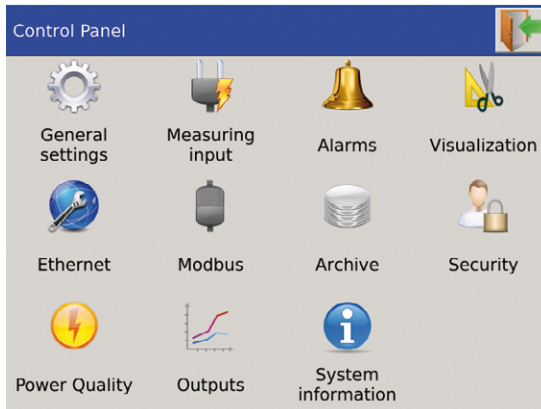

	L1 [%]	L2 [%]	L3 [%]
THD	2.34	2.35	2.34
THDG	2.34	2.35	2.34
THDS	0.00	0.00	0.00
PWHD	2.34	2.35	2.34
1	100.00	100.00	100.00
2	0.05	0.04	0.05
3	0.78	0.79	0.78
4	0.02	0.02	0.02
5	0.63	0.63	0.63
6	0.02	0.02	0.02
7	1.78	1.79	1.78
8	0.03	0.03	0.03
9	0.66	0.66	0.66
10	0.03	0.03	0.03

## EXAMPLES OF MEASURING DATA PRESENTATION

Energy			13:08:41 2019-01-04
	value	unit	
Σ EnP+	00000000.0	kWh	
L1	00000000.0	kWh	
L2	00000000.0	kWh	
L3	00000000.0	kWh	
Σ EnP-	00000000.0	kWh	
L1	00000000.0	kWh	
L2	00000000.0	kWh	
L3	00000000.0	kWh	
Σ EnQ+	00000000.0	kVARh	
L1	00000000.0	kVARh	

Binary inputs				14:07:45 2019-01-04
	BI1		BI2	
	1		0	
	BI3		BI4	
	0		0	
	BI5		BI6	
	0		0	

Alarm logs				14:18:23 2019-01-04
No	Date	Time	Description	
43	2016-01-20	13:49:54	Alarm 2 - Wf. (Urms L2 200ms 224.811V) (> 210)	
42	2016-01-20	13:49:54	Alarm 1 - Wf. (Urms L1 200ms 224.823V) (> 200)	
41	2016-01-20	08:53:15	Alarm 1 - Wf. (Urms L1 200ms 240.477V) (> 200)	
40	2016-01-19	16:00:19	Alarm 2 - Wf. (Urms L2 200ms 229.91V) (> 210)	
39	2016-01-19	16:00:19	Alarm 1 - Wf. (Urms L1 200ms 229.898V) (> 200)	
38	2016-01-19	15:36:32	Alarm 2 - Wf. (Urms L2 200ms 228.824V) (> 210)	
37	2016-01-19	15:36:31	Alarm 1 - Wf. (Urms L1 200ms 228.798V) (> 200)	

## ETHERNET: WWW SERVER, FTP

## DIMENSIONS AND ASSEMBLY

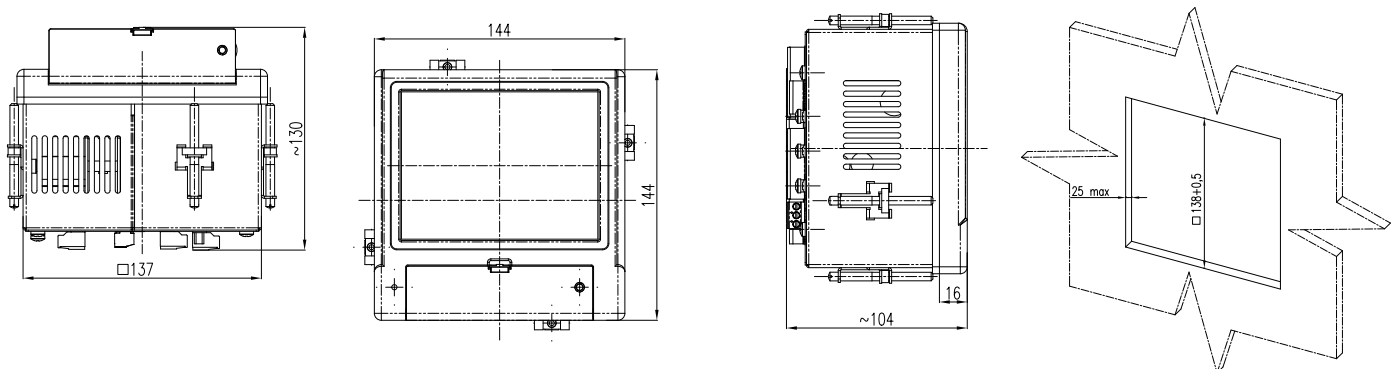

## ORDERING CODE

Code	Description
<b>ND45 1010M000*</b>	Power Network Analyzer/ Recorder ND45 Input current 1A/5A, X/1A, X/5A, Input voltage 3x57.7/100V, Measuring class S, Ethernet, RS485, USB interfaces, memory up to 32GB, supply 85-253V a.c. or 90-300V d.c., documentation and descriptions in Polish and English version, test certificate
<b>ND45 1011M000*</b>	Power Network Analyzer/ Recorder ND45 Input current 1A/5A, X/1A, X/5A, Input voltage 3x57.7/100V, Measuring class A/S, Ethernet, RS485, USB interfaces, memory up to 32GB, supply 85-253V a.c. or 90-300V d.c., documentation and descriptions in Polish and English version, test certificate
<b>ND45 2010M000*</b>	Power Network Analyzer/ Recorder ND45 Input current 1A/5A, X/1A, X/5A, Input voltage 3x230/400V, Measuring class S, Ethernet, RS485, USB interfaces, memory up to 32GB, supply 85-253V a.c. or 90-300V d.c., documentation and descriptions in Polish and English version, test certificate
<b>ND45 2011M000*</b>	Power Network Analyzer/ Recorder ND45 Input current 1A/5A, X/1A, X/5A, Input voltage 3x230/400V, Measuring class A/S, Ethernet, RS485, USB interfaces, memory up to 32GB, supply 85-253V a.c. or 90-300V d.c., documentation and descriptions in Polish and English version, test certificate

\* Upon agreement, an option to order a calibration certificate for the product is available against payment. Then, in the execution code, in the place of the last character, enter the digit 2, e.g. **ND45 2011M002**. The customer will then receive a standard test certificate and a calibration certificate (against payment).

For more information about Lumel products  
please visit our website:

[www.lumel.com.pl](http://www.lumel.com.pl)

Join us at Facebook!



ND45-19B\_R1