

Serie

DMNE11

Información general de los modelos DMNE113xF, DMNE114xF, DMNE115xF y DMNE116xF.



Foto DMNE114RF

Descripción





- El **DMNE11_xF** es un producto de la serie DMNE de marcadores numéricos monocolor.
- Dispone de una altura de carácter de 11 cm, obteniendo una distancia máxima de legibilidad de 50 m.
- Los dígitos se representan a través las líneas que forman los 7 segmentos.
- Los marcadores pueden ser de 3, 4, 5 o 6 dígitos según el modelo.
- Los LEDs son en monocolor rojo (R) aunque opcionalmente se puede poner en color blanco (W) o ámbar (A).
- Dispone de sensor de luminosidad para ajustar de manera automática la intensidad de los LEDs según la luminosidad.
- Diseñado para ambientes de interior y exterior.
- Comunicación nativa mini USB.
- Permite además escoger un módulo de comunicación según necesidades.
- En el apartado comunicaciones se detallan todas las posibilidades.
- Software MPTools para Windows. Este software nos permite establecer valores numéricos, así como modificar su configuración.
- El chasis está fabricado mediante el uso de perfil de aluminio extrusionado, garantizando la máxima robustez del equipo, así como su mínimo peso.
- Además, se utilizan materiales de altas prestaciones con el fin de otorgar al producto una gran durabilidad.



Especificaciones técnicas

VISUALIZACIÓN	DMNE113xF	DMNE114xF	DMNE115xF	DMNE116xF
Altura de carácter (cm)	11			
Nº dígitos	3	4	5	6
Ancho del trazo (nº LEDs)	1			
Área visualización (H x V) (mm)	282 x 112	388 x 112	382 x 112	582 x 112
Diámetro del LED (mm.)	5			
Color	Monocolor rojo (blanco o ámbar opcional)			
Distancia legibilidad (m)	50			
ELÉCTRICAS				
Microprocesador	16 bits			
Alimentación	230V AC +/- 15 % / 50hz			
Consumo máximo (W)	10	13	16	20
Temperatura de trabajo (°C)	Temperatura ambiente entre -10º y +45º			
Tipo de alimentación	Fuente de alimentación conmutada incorporada en el interior			

Comunicaciones

Los módulos de comunicación compatibles son los siguientes:

MÓDULOS OPCIONALES	
	<p>Módulo X Comunicación serie RS232 ó RS485.</p>
	<p>Módulo NE Comunicación Ethernet TCP/IP.</p>
	<p>Módulo NW Comunicación inalámbrica WiFi.</p>
	<p>Módulo AN 2 entradas analógicas de 0 – 10 V ó 4 - 20 mA configurables.</p>
	<p>Módulo K4 4 entradas digitales para incrementar/disminuir un contador.</p>

PERIFÉRICOS	
	<p>Mando IR Mando infrarrojo con un alcance máximo de unos 8 m.</p>
	<p>Mando RF Mando radiofrecuencia con un alcance máximo de unos 50 m.</p>
	<p>Salidas relé RE Podremos gestionar alarmas en el display para que se active uno o dos relés.</p>

Software



MP Tools (Windows): Software gratuito diseñado para ajustar los parámetros de configuración, así como la gestión de las alarmas o cambiar los valores numéricos. Para más detalle consultar el manual del MP Tools.

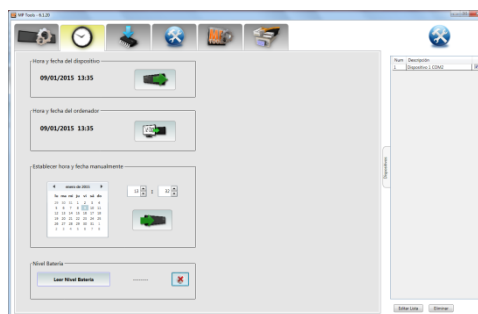

Dimensiones

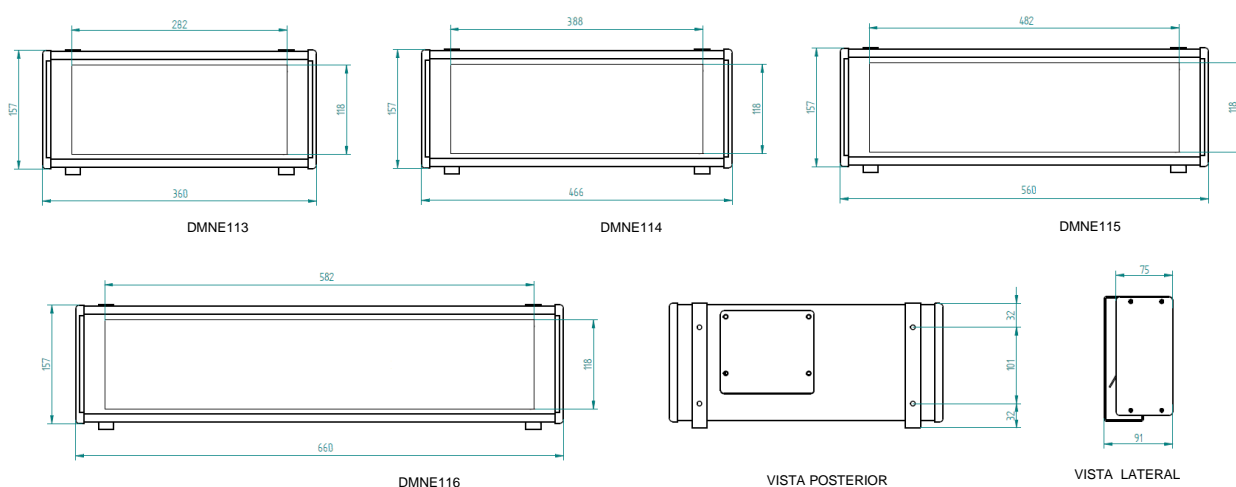

CONSTRUCTIVAS	DMNE113xF	DMNE114xF	DMNE115xF	DMNE116xF
Chasis				
Largo (L) x Alto (H) (mm)	360 x 157 mm	466 x 157 mm	560 x 157 mm	660 x 157 mm
Fondo (W) (mm)	75 mm. (91 mm con anclaje)			
Peso aproximado (Kg)	2,3 Kg	2,8 kg	3,3 kg	3,8 kg
Grado de protección	IP54			
Material del frontal	Metacrilato fumé			
Material del chasis	Aluminio extrusionado			
Color del chasis	Negro			
Sujeción	Mediante accesorios incluidos			

Série

DMNE11

Informations générales pour les modèles MNE113xF,
DMNE114xF, DMNE115xF et DMNE116xF.



Photo DMNE114RF

Description





- Le **DMNE11_xF** est un produit de la serie DMNE d'afficheurs numériques monochromes
- Il a une hauteur de caractère de 11 cm, obtenant une distance de lisibilité maximale de 50 m.
- Les digits sont représentés par les lignes qui forment les 7 segments.
- Les afficheurs peuvent comporter 3, 4, 5 ou 6 digits selon le modèle.
- Les LED sont monochromes rouges (R), bien qu'elles puissent en option être blanc (W) ou orange (A).
- Il dispose d'un capteur de luminosité pour ajuster automatiquement l'intensité des LED en fonction de la luminosité.
- Conçu pour les environnements intérieurs et extérieurs.
- Communication native mini-USB.
- Il permet également de choisir un module de communication en fonction des besoins. Toutes les possibilités sont détaillées dans la section communications.
- Logiciel MPTools pour Windows. Ce logiciel nous permet d'établir des valeurs numériques, ainsi que de modifier sa configuration.
- Le châssis est fabriqué en profilé d'aluminium extrudé, garantissant une robustesse maximale de l'équipement, ainsi que son poids minimum.
- De plus, des matériaux performants sont utilisés afin de conférer au produit une grande durabilité.



Spécifications techniques

AFFICHAGE	DMNE113xF	DMNE114xF	DMNE115xF	DMNE116xF
Hauteur des caractères (cm)	11			
N° digits	3	4	5	6
Largeur du trait (n° LEDS)	1			
Zone d'affichage (H x V) (mm)	282 x 112	388 x 112	382 x 112	582 x 112
Diamètre des LED (mm.)	5			
Couleur	Rouge (blanc ou ambre en option)			
Distance de lisibilité (m)	50			
ÉLECTRIQUES				
Microprocesseur	16 bits			
Alimentation	230V AC +/- 15 % / 50hz			
Consommation maximale (W)	10	13	16	20
Température de travail (°C)	-10°C à +45°C			
Type d'alimentation	Alimentation à découpage intégrée à l'intérieur			

Communications

Les modules de communication supportés sont les suivants:

MODULES OPTIONNELS	
	<p>Module X Communication série RS232 ou RS485.</p>
	<p>Module NE Communication Ethernet TCP/IP.</p>
	<p>Module NW Communication sans fil WiFi.</p>
	<p>Module AN 2 entrées analogiques de 0 – 10 V ou 4 - 20 mA configurables.</p>
	<p>Module K4 4 entrées numériques pour incrémenter/décroître un compteur.</p>

PÉRIPHÉRIQUES	
	<p>Commande IR Commande infrarouge avec une portée maximale d'environ 8 m.</p>
	<p>Commande RF Commande radiofréquence avec une portée maximale d'environ 50 m.</p>
	<p>Sorties relais RE Nous pouvons gérer les alarmes sur l'écran afin qu'un ou deux relais soient activés.</p>

Logiciel



MP Tools (Windows): Logiciel gratuit conçu pour ajuster les paramètres de configuration ainsi que pour gérer les alarmes ou modifier les valeurs numériques. Pour plus de détails, consultez le manuel MP Tools.



Dimensions

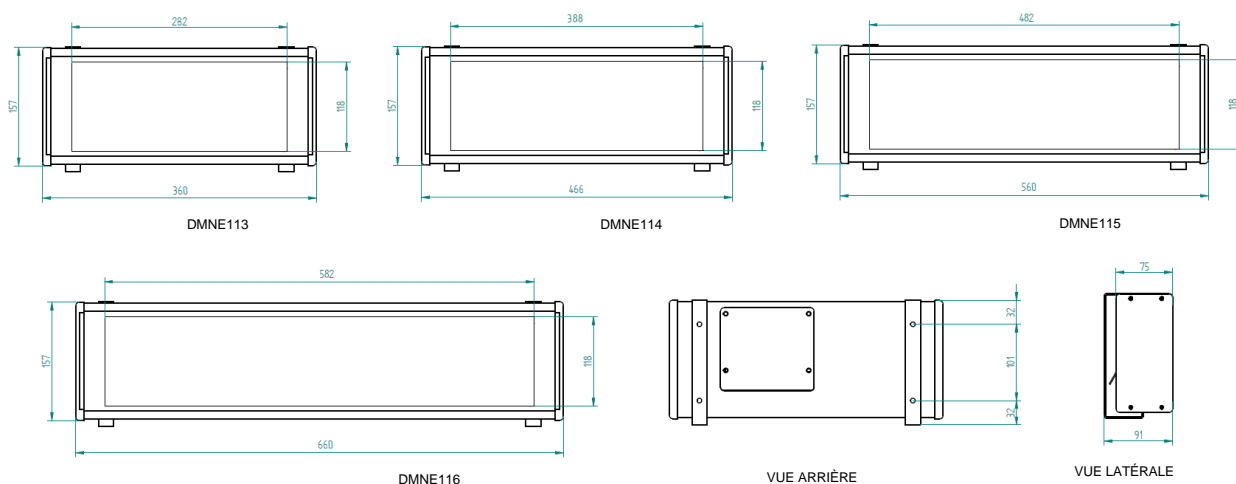

CONSTRUCTIVES	DMNE113xF	DMNE114xF	DMNE115xF	DMNE116xF
Châssis				
Longueur (L) x Hauteur (H)	360 x 157 mm	466 x 157 mm	560 x 157 mm	660 x 157 mm
Profondeur (W) (mm)	75 mm. (91 mm avec supports)			
Poids approx. (Kg)	2,3 Kg	2,8 kg	3,3 kg	3,8 kg
Degré de protection	IP54			
Matériau face avant	Méthacrylate fumé			
Matériau du châssis	Aluminium extrudé			
Couleur du châssis	Noir			
Fixation	Utiliser les accessoires fournis			

DMNE11 Series

General information of the models DMNE113xF, DMNE114xF, DMNE115xF y DMNE116xF.



Photo DMNE114RF

Description





- The **DMNE11_xF** is a product of the DMNE series of single-color numerical displays.
- It has a character height of 11 cm, obtaining a maximum readability distance of 50 m.
- The digits are represented through the lines that form the 7 segments.
- Displays can be 3, 4, 5 or 6 digits depending on the model.
- The LEDs are monochrome red (R), although they can optionally be set to white (W) or amber (A).
- It has a brightness sensor to automatically adjust the intensity of the LEDs according to the brightness.
- Designed for indoor and outdoor environments.
- Native mini USB communication.
- It also allows you to choose a communication module according to needs. All the possibilities are detailed in the communications section.
- MPTools software for Windows. This software allows us to establish numerical values, as well as modify its configuration.
- The chassis is manufactured using extruded aluminum profile, guaranteeing maximum robustness of the equipment, as well as its minimum weight.
- In addition, high-performance materials are used in order to give the product great durability.



Technical specifications

DISPLAY	DMNE113xF	DMNE114xF	DMNE115xF	DMNE116xF
Character height (cm)	11			
Nº digits	3	4	5	6
Segment width (nº of LEDES)	1			
Display area (L x H) (mm)	282 x 112	388 x 112	382 x 112	582 x 112
LED diameter (mm.)	5			
Color	Red single color (white or amber optional)			
Readability distance (m)	50			
ELECTRICAL				
Microprocessor	16 bits			
Power Supply	230V AC +/- 15 % / 50hz			
Maximum consumption (W)	10	13	16	20
Operating temperature (°C)	-10°C to +45°C			
Power supply type	Switching power supply built inside			

Communications

The supported communication modules are the following:

OPTIONAL MODULES	
	<p>Module X RS232 or RS485 serial communication.</p>
	<p>Module NE Ethernet TCP/IP communication.</p>
	<p>Module NW WiFi wireless communication.</p>
	<p>Module AN 2 configurable 0 – 10 V or 4 – 20 mA analog inputs.</p>
	<p>Module K4 4 digital inputs to increment/decrement a counter.</p>

PERIPHERALS	
	<p>IR command Infrared control with a maximum range of about 8 m.</p>
	<p>RF command Radio frequency control with a maximum range of about 50 m.</p>
	<p>RE relay outputs We can manage alarms on the display so that one or two relays are activated.</p>

Software



Tools (Windows): Free software designed to adjust configuration parameters, as well as manage alarms or change numerical values. For more details consult the MP Tools manual.

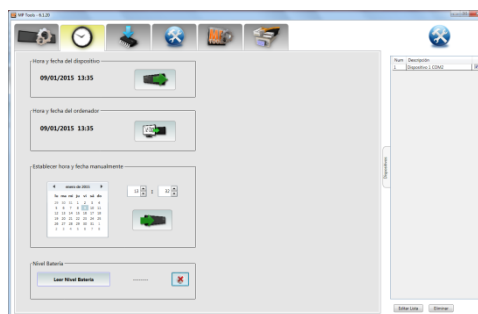

Dimensions

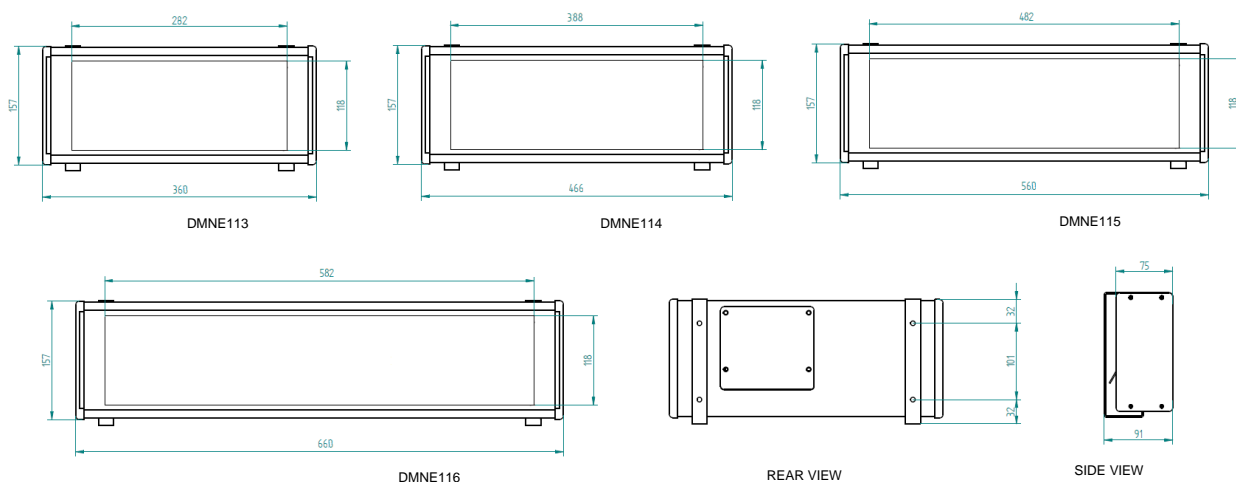

CONSTRUCTIVES	DMNE113xF	DMNE114xF	DMNE115xF	DMNE116xF
Chassis				
Length (L) x Height (H) (mm)	360 x 157 mm	466 x 157 mm	560 x 157 mm	660 x 157 mm
Width (W) (mm)	75 mm. (91 mm with supports)			
Approximate weight (Kg)	2,3 Kg	2,8 kg	3,3 kg	3,8 kg
Degree of protection	IP54			
Front material	Smoke methacrylate			
Chassis material	Extruded aluminum			
Chassis color	Black			
Fixation	Using included accessories			